

Keysight Technologies

Understanding Phase Noise Needs and Choices in Signal Generation

Application Note



Introduction

The phase noise performance of an RF or microwave signal generator is often a key factor in determining how well it fits an application. For example, phase noise performance is especially important in the testing of high-performance systems such as Doppler radars and cognitive or software-defined radios (SDRs). Excellent phase noise specifications are also important when using a signal generator for oscillator substitution or analog-to-digital converter (ADC) testing.

When evaluating an RF or microwave signal generator for use in such applications, several performance factors are worth a close look: spurious, harmonics, broadband noise, AM noise and phase noise. Looking specifically at phase noise performance, it is affected by the internal architecture of the instrument and the features and capabilities layered on top of that architecture. The most common architectures are single-loop and double-loop, and these will be explored later in this note. Available features include digital modulation capabilities, pulse capabilities and multi-unit synchronization—and the presence of these can affect phase noise performance.

In both the design and evaluation of a signal generator, phase noise performance includes tradeoffs such as cost, switching speed and optimization at various frequency offsets from the carrier signal. To address a variety of requirements, some signal generators offer two or more levels of phase noise performance (e.g., standard and optional capabilities). Others allow optimization of phase noise performance at wide or narrow offsets. Still others may allow the user to selectively degrade phase noise performance and observe the effects on the device-under-test (DUT).

To provide context, this note first discusses the fundamentals of phase noise before moving on to a closer look at architectural choices and the effects of various functionality alternatives. The discussion then moves on to an overview of Keysight Technologies, Inc. signal generators and the built-in capabilities they offer to enhance or selectively degrade phase noise performance.

The foundation: stability and noise

Any discussion of phase noise is mostly concerned with the frequency stability of a signal. Long-term stability, perhaps of an oscillator, may be characterized in terms of hours, days, months, or even years. Short-term stability refers to frequency changes that occur over a period of a few seconds or less. These short-cycle variations have a much greater effect on systems that rely on extreme processing to extract more information from a signal. For that reason, this discussion will focus on short-term stability.

Short-term stability can be described in many ways but the most common is single-sideband (SSB) phase noise. The US National Institute of Standards and Technology (NIST) defines SSB phase noise as the ratio of two power quantities: the power density at a specific frequency offset from the carrier and the total power of the carrier signal. This is most commonly measured in a 1-Hz bandwidth at a frequency “f” away from the carrier and the units are dBc/Hz or “decibels below carrier frequency power over a 1-Hz bandwidth.”

The level of phase noise is deterministically related to the carrier frequency, increasing by 6 dB for every doubling in frequency. When characterizing the performance of components integrated into advanced radar and communication systems, measurements of phase noise for a 1 GHz carrier may extend from roughly -40 dBc/Hz at “close to the carrier” offsets (1 Hz or less) down to -150 dBc/Hz at “far from the carrier” offsets (10 kHz or more). These measurements will be about 18 dB higher with a carrier frequency of 8 GHz. At such low levels, the measurement noise floor is affected by two microscopic electronic effects: thermal noise from passive devices, which is broad and flat (white noise); and flicker noise from active devices, which has a $1/f$ shape (pink noise) that emerges from the thermal noise at lower offsets. Both of these contributors are unavoidable because they are present all along the signal chain: in the measuring instrument, in the device that produces the signal-under-test (SUT), and even in the cables that connect the two.

Another sometimes overlooked source of noise is any type of amplifier in the signal chain. While the main purpose is to increase the power level of a weak carrier signal, the amplifier adds its own noise and also boosts any input noise. The net effect: amplifier, thermal and flicker noise combine to give any phase noise plot a characteristic shape and, more significantly, reduce the theoretical lower limit of any phase noise measurement (Figure 1).

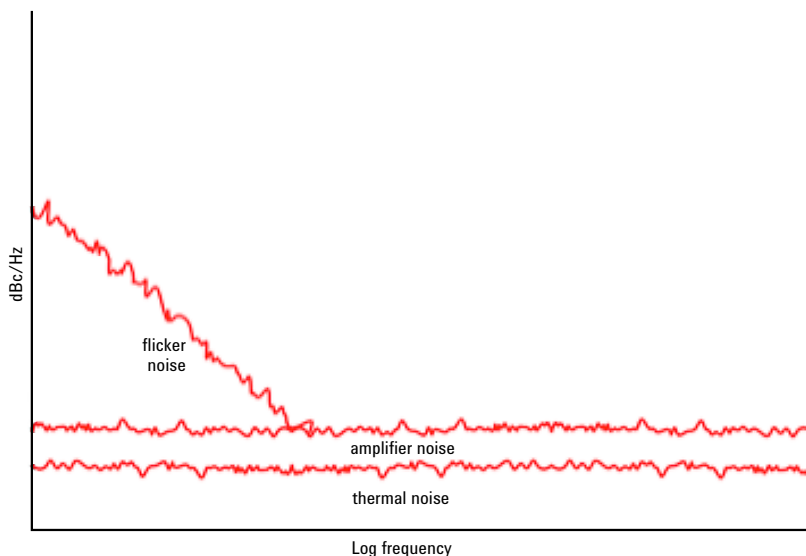

Figure 1. The three main contributors to noise create a theoretical lower limit for phase noise measurements.

The foundation: stability and noise (continued)

These effects all show up in the phase noise characteristics of a high-performance signal generator. For example, the underlying sources of noise can be traced back to the major sections of the instrument block diagram (Figure 2). For offsets below 1 kHz, the noise is dominated by the performance of the reference oscillator, which is multiplied up to the carrier frequency. The other major contributors are the synthesizer at offsets of 1 kHz to roughly 100 kHz, the yttrium-iron-garnet (YIG) oscillator from 100 kHz to 2 MHz, and the output amplifier at offsets above 2 MHz. When these effects are well understood, they can be minimized and optimized within a system design to ensure maximum performance.

Looking at the relationship between phase noise and frequency, phase noise increases deterministically as frequency increases. This is especially true when frequency-multiplying techniques are used either inside or outside of the signal generator. The actual relationship is often affected by small changes in frequency or band.

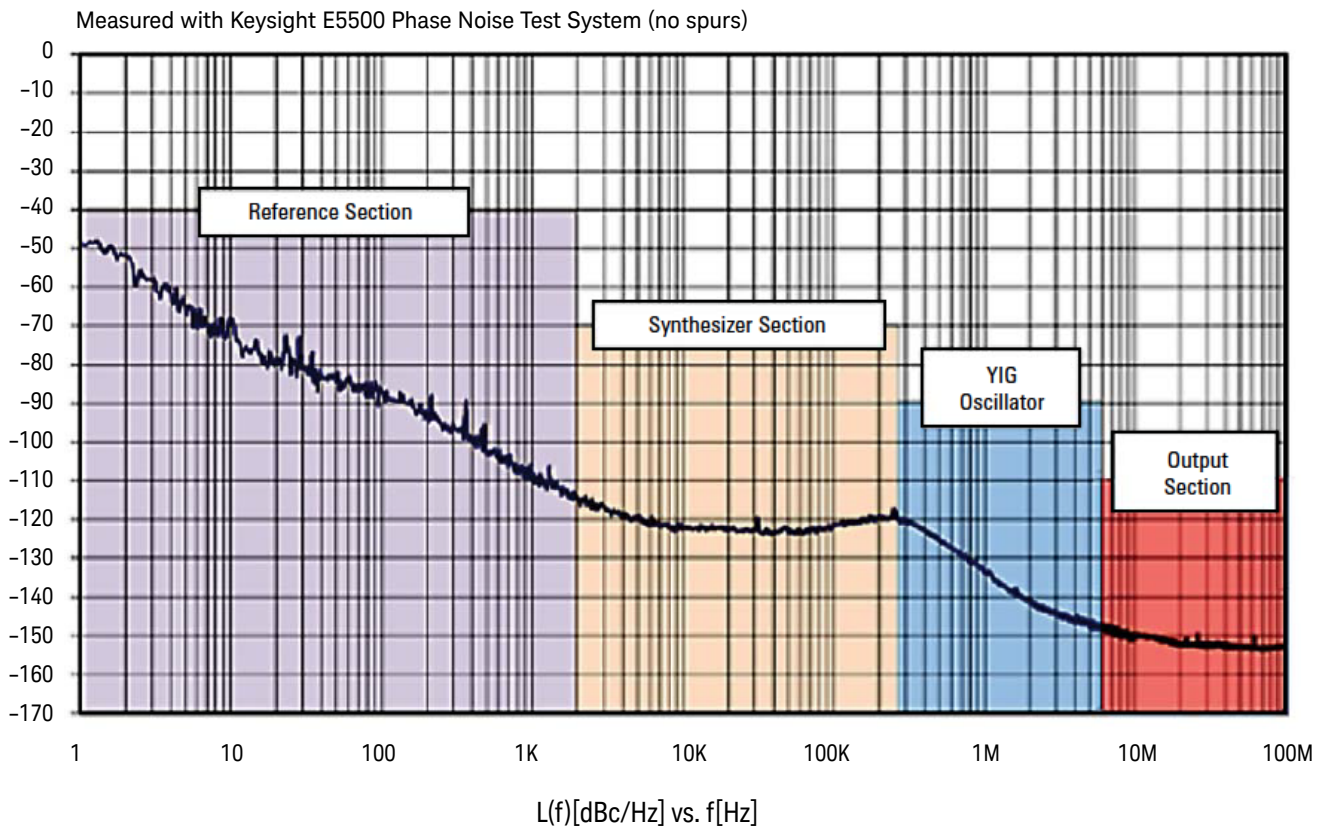

Figure 2. Contributions to the phase noise performance of a signal generator can be traced to the major sections of its internal architecture.

Signal generator architectures

Two types of architectures are common: single-loop and multiple-loop phase-locked loops (PLLs). The single-loop approach is less complex, which makes it simpler to design and optimize. It also tends to be less expensive, but the lower cost comes with a tradeoff: single-loop synthesizers tend to provide moderate levels of phase noise performance (but very good adjacent-channel power ratio or ACPR).

Multiple-loop designs are more complex and therefore typically more expensive. The additional elements may include a fine loop, an offset or step loop and a summing loop, all of which contribute to lower spurious levels and significant improvements in phase noise performance (Figure 3). If certain loop-adjustment controls are made user-accessible, a multi-loop synthesizer provides greater flexibility in the optimization of phase noise performance to suit a specific application.

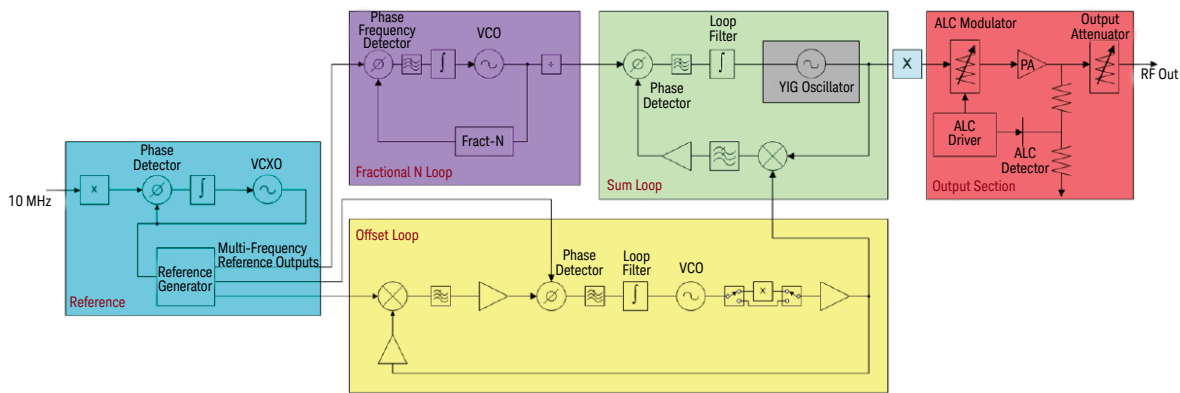

Figure 3. As implemented in the Keysight PSG and MXG signal generators, this triple-loop architecture enables tremendous improvements in phase noise performance.

To illustrate the differences, Figure 4 shows phase noise plots from three Keysight X-Series signal generators: the EXG, the standard MXG and the MXG with the “enhanced low phase noise” option (UNY). There are clear differences in performance between the single-loop EXG and the multi-loop MXG, with or without the low phase noise option.

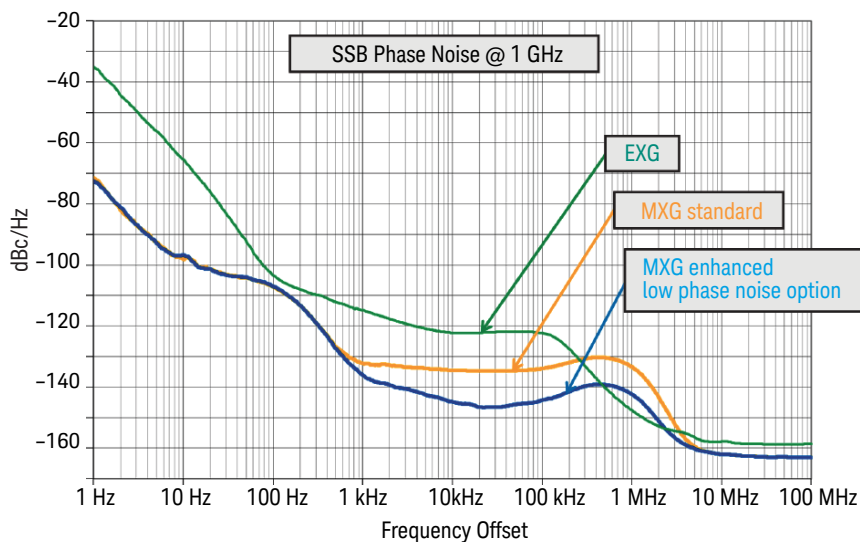

Figure 4. While the single-loop EXG is suitable for many situations, the multiple-loop MXG offers a substantial improvement for high-performance applications.

Signal generator architectures (continued)

Digging one layer deeper within any architecture, the type of oscillator can also affect phase noise performance. For example, signal generators that use a voltage-controlled oscillator (VCO) will generally provide worse phase noise performance than one that uses a YIG oscillator in the synthesizer section (Figure 5). This has a tradeoff: YIG-based signal generators generally provide slower switching speeds than do VCO-based designs.

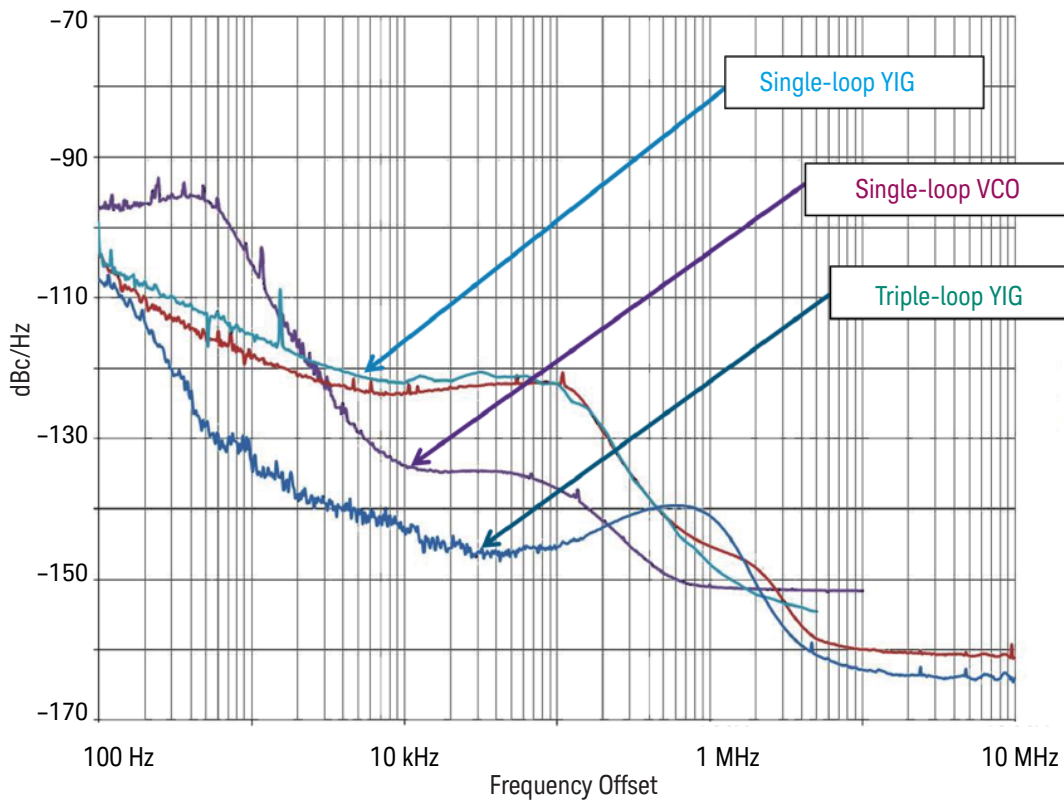

Figure 5. Inside a signal generator, the combination of architecture and oscillator type affects the overall amount of phase noise as well as the distribution of phase noise versus offset and frequency.

One more architectural element is worth mentioning: reference sources, either internal or external. Within the signal generator architecture, the noise performance of the frequency reference has a major influence on phase noise. Under the heading “designer’s choice,” most RF and microwave signal generators include a high-quality internal 10-MHz reference and offer a higher-performance 10-MHz reference as an option. In the realm of “user’s choice,” most signal generators provide an external input for a known, high-performance 10-MHz reference.

Taking this one step farther, the Keysight PSG signal generators can be configured with an input that accepts a 1-GHz external frequency reference (option H1S). In this mode, the PSG bypasses the internal reference assembly, negating its additive phase noise when using a 10-MHz reference (internal or external).

Signal generator capabilities

Within the various RF and microwave signal generators currently on the market, a variety of capabilities are available. At the basic level, the first choice is between continuous-wave (CW) or analog signal generators (analog-modulation capable) and vector signal generators (VSGs; capable of analog and vector modulation). For those who need a “golden source” in a lab setting, a high-performance CW or analog signal generator is often the default choice. However, if more functionality will be of use, a VSG includes vector, or digital, modulation (e.g., I and Q modulation inputs) and sometimes offers pulse modulation, which is useful for simulation of Doppler radar signals.

A VSG may include a baseband arbitrary waveform generation (AWG) capability along with deep internal waveform memory. Some, such as the MXG vector signal generator (N5182B), also support real-time simulation of complex real-world signals. This is typically done in combination with signal-creation software such as Keysight Signal Studio to support a variety of applications:

- Cellular communications, including Verizon Pre-5G, LTE/LTE-A-FDD/TDD
- GNSS with up to 32 GPS and GLONASS line-of-site satellites
- DVB-T/H with a continuous PN23 or up to two hours of video playback
- Custom modulation such as AWGN or 1024QAM
- AWGN and phase-noise impairments

The presence of the various digital capabilities within the signal generator may have an effect on phase noise performance. The specifics of the possible interactions vary and can be quite complex. As a result, it’s important to consult the detailed specifications for any signal generator and compare the performance levels to your full set of application requirements.

Keysight signal generators

Keysight’s X-Series signal generators provide excellent performance in terms of phase noise, output power, ACPR, error vector magnitude (EVM) and bandwidth. The Keysight EXG N5171B analog signal generators and N5172B vector signal generators are examples of cost-effective single-loop synthesizers. The Keysight N5181B analog signal generators and N5182B vector signal generators utilize the triple-loop PLL architecture shown in Figure 3 to provide excellent performance in spurious and phase noise.

In the MXG, one key to improved phase noise is the frequency plan, which is optimized for the triple-loop topology. The frequency plan addresses several attributes: the choice of oscillator and reference frequencies in the synthesizer sum and offset loops, and the associated frequency conversion (mixers and multipliers) and filtering.

The triple-loop approach allows optimized frequency spacing that ensures effective filtering of nonlinear artifacts (e.g., images) by pushing them outside the bandwidth of the synthesizer circuits. In the MXG, the plan arranges the frequency references and conversions such that the largest nonlinearities are far from the desired frequencies and modest filtering can heavily attenuate the remaining spurious signals. Moving the large nonlinearities also allows internal signal levels to be set higher, resulting in relatively lower broadband noise and improved dynamic range.

Keysight signal generators (continued)

With these capabilities, the MXG supports the development of components and receivers that meet the challenges of increased interference, data throughput and signal quality in applications such as commercial wireless, military communications and radar.

As an example, today's aerospace/defense environment requires enhanced radar performance to detect weak signals at long distances. To provide the pure and precise signals needed to test these designs, the MXG delivers phase noise performance as good as -146 dBc/Hz at 1 GHz and 20 kHz offset with option UNY, enhanced low phase noise (Figure 6). Option UNY is recommended for signal-generation applications such as LO substitution or blocking signals that require spectrally pure signals or outstanding modulation accuracy. For developers of radar components such as mixers and analog-to-digital converters, the MXG also features spurious performance of -96 dBc at 1 GHz.

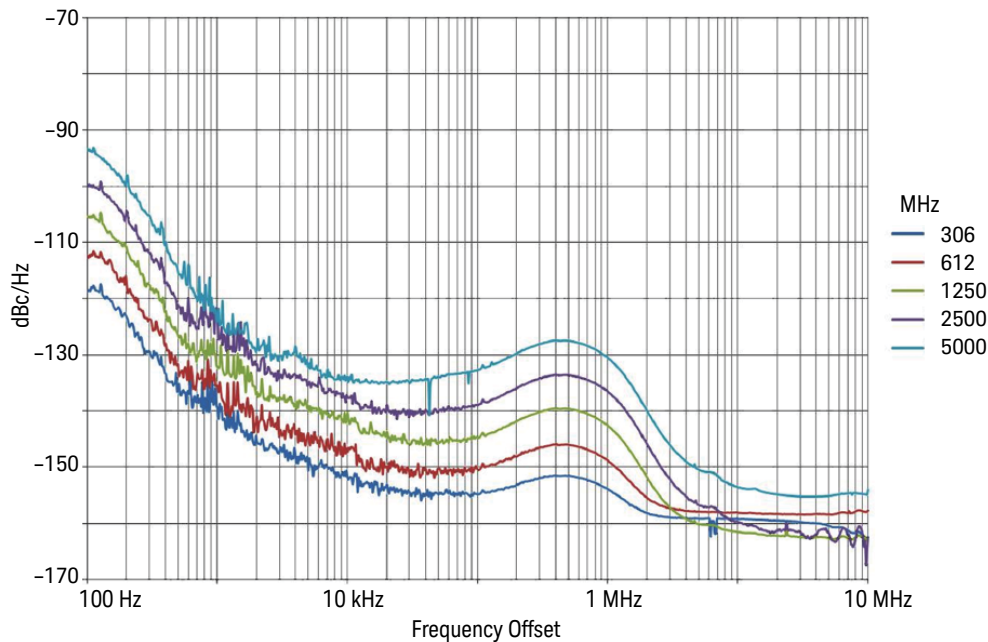

Figure 6. In the MXG, option UNY adds an advanced phase-locked loop along with a low-noise internal frequency reference, improving close-in and pedestal phase stability and providing superior phase noise performance.

In wireless communications, demand for more data and better coverage is driving higher performance in consumer devices and network-infrastructure equipment. For those developing faster data streaming in 802.11ac devices and beyond, the MXG is currently the only solution with factory-equalized 160-MHz RF bandwidth, providing real-time flatness correction to ± 0.2 dB. For designers seeking to enhance range, mitigate interference and boost component performance, both the MXG and EXG deliver three industry-leading capabilities: low EVM, output power up to $+26$ dBm, and ACPR of up to -73 dBc (W-CDMA test model 1, 64 DPCH).

Optimizing phase noise performance

A variety of alternatives can help you optimize the phase noise performance of a signal generator. Some, as described earlier, are architectural choices made by the instrument designers—and understanding the implications of those choices is an important step toward selecting the best signal generator for your application. Other choices are up to you: operating techniques, instrument settings, external references and test-system configuration.

Another opportunity for optimization is user-accessible adjustments built into the signal generator. For example, current-generation Keysight instruments equipped with options UNY (mentioned above) or UNX, low phase noise, include an adjustment for the reference-oscillator bandwidth (sometimes called loop bandwidth). The bandwidth is adjustable in fixed steps of 25, 55, 125, 300 and 650 Hz for either an internal or external 10-MHz reference. As a rule of thumb, the wider the bandwidth, the lower the close-in phase noise, especially at offsets below 100 Hz.

When using this adjustment to optimize phase noise performance for a specific application, the point of reference is your confidence in the stability and phase noise of the external or internal frequency reference versus the synthesizer hardware for various offsets from the carrier. The internal or external reference determines stability and phase noise at frequency offsets below approximately 1 kHz, and the synthesizer hardware determines stability and phase noise at offsets above 1 kHz.

Option UNY also includes integrated frequency dividers to enable a dividing technique when generating output carrier frequencies below 250 MHz. This reduces phase noise by a factor of 20 dB/decade or 6 dB/octave at all offsets for these frequencies; however, maximum FM and PM deviations are reduced by the same factor as the divider value.

When the dividers are disabled, the signal generator returns to the standard mode of creating low frequencies with a heterodyning technique. Heterodyne mixing provides fine frequency adjustment while retaining full bandwidth when using FM or PM. The tradeoff: mixing to lower frequencies provides no reduction in phase noise.

Applying precise imperfections

The extremely low phase noise of the MXG is not always required and a process called phase noise injection enables selective and precise degradation as needed. Signal generators are often used to generate complex modulated RF signals and to substitute for various oscillators or synthesizers in the design process.

In real-world designs, any improvement in frequency stability is expensive in terms of cost, power and space. As a result, many engineers have an interest in creating assemblies with performance that is just good enough. The process of arriving at just good enough is faster and easier if the phase noise of a test source is precisely adjustable.

In the MXG, a real-time signal-processing ASIC customizes phase noise levels for both CW and modulated signals. In an important innovation, phase noise can be adjusted to different levels at different offsets, including the steep slopes of close-in noise, the flat slopes of synthesizer pedestal noise and the shallow slopes of wide-offset noise.

This precise substitution capability can help you avoid the dual hazards of over- or under-performance of your oscillators and synthesizers. Excess performance can lead to expensive designs and longer design cycles, rendering a product uncompetitive. Insufficient performance results in redesigns and product delays and the type of unpleasant surprises that engineers dread most.

OFDM signals provide a good example. Because these signals have extremely close subcarrier spacing, they are sensitive to phase noise, which reduces the orthogonality (independence) of the subcarriers and increases modulation error. Consequently, OFDM transmitters and receivers need good phase noise performance. During product development, the MXG's injection capability allows selective addition of phase noise in terms of carrier offset, making it an excellent substitute for synthesizers and OFDM transmitters and enabling confident evaluation of receiver tolerance versus real-world transmitter performance. The result is fast, reliable optimization of design cost and performance.

Conclusion

Phase noise performance is often the key factor in determining the suitability of a signal generator for a demanding application. Getting the best possible phase noise performance depends on a variety of factors: internal architecture, type of oscillator, internal and external frequency references, and the effects of additional built-in capabilities. The tradeoffs around these attributes include switching speed, optimization for close-in or far-out offsets and cost.

As a result, there are many paths to optimum phase noise performance—just as it takes many paths to truly understand a device’s behavior. This concept is one of the key ideas behind the Keysight X-Series signal generators. They are designed to produce a variety of signals—from simple to complex, from clean to impaired—that enable testing within and beyond the limits of your very best devices. Within the X-Series, the MXG provides optional features and capabilities that let you optimize it for precise testing of high-performance designs.

Related information

Application Note: Reducing Phase Noise at RF and Microwave Frequencies, publication 5990-7529EN

Product Brochure: MXG & EXG X-Series Signal Generators, publication 5990-9957EN

Data Sheet: MXG X-Series Signal Generators, N5181B Analog & N5182B Vector, publication 5991-0038EN

Data Sheet: EXG X-Series Signal Generators, N5171B Analog & N5172B Vector, publication 5991-0039EN

Product Brochure: PSG Signal Generators, publication 5989-1324EN

Data Sheet: E8257D PSG Microwave Analog Signal Generator, publication 5989-0698EN

Data Sheet: E8267D PSG Vector Signal Generator, publication 5989-0697EN

Data Sheet: E8663D PSG RF Analog Signal Generator, publication 5989-4136EN

Evolving Since 1939

Our unique combination of hardware, software, services, and people can help you reach your next breakthrough. We are unlocking the future of technology.

From Hewlett-Packard to Agilent to Keysight.

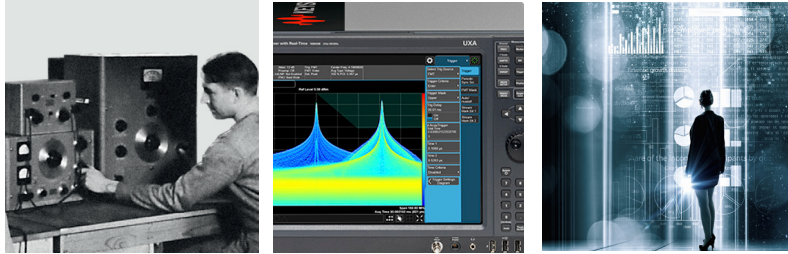

myKeysight

myKeysight

www.keysight.com/find/mykeysight

A personalized view into the information most relevant to you.

http://www.keysight.com/find/emt_product_registration

Register your products to get up-to-date product information and find warranty information.

KEYSIGHT SERVICES

Accelerate Technology Adoption.
Lower costs.

Keysight Services

www.keysight.com/find/service

Keysight Services can help from acquisition to renewal across your instrument's lifecycle. Our comprehensive service offerings—one-stop calibration, repair, asset management, technology refresh, consulting, training and more—helps you improve product quality and lower costs.



Keysight Assurance Plans

www.keysight.com/find/AssurancePlans

Up to ten years of protection and no budgetary surprises to ensure your instruments are operating to specification, so you can rely on accurate measurements.

Keysight Channel Partners

www.keysight.com/find/channelpartners

Get the best of both worlds: Keysight's measurement expertise and product breadth, combined with channel partner convenience.

www.keysight.com/find/signalgenerator

For more information on Keysight Technologies' products, applications or services, please contact your local Keysight office. The complete list is available at:

www.keysight.com/find/contactus

Americas

Canada	(877) 894 4414
Brazil	55 11 3351 7010
Mexico	001 800 254 2440
United States	(800) 829 4444

Asia Pacific

Australia	1 800 629 485
China	800 810 0189
Hong Kong	800 938 693
India	1 800 11 2626
Japan	0120 (421) 345
Korea	080 769 0800
Malaysia	1 800 888 848
Singapore	1 800 375 8100
Taiwan	0800 047 866
Other AP Countries	(65) 6375 8100

Europe & Middle East

Austria	0800 001122
Belgium	0800 58580
Finland	0800 523252
France	0805 980333
Germany	0800 6270999
Ireland	1800 832700
Israel	1 809 343051
Italy	800 599100
Luxembourg	+32 800 58580
Netherlands	0800 0233200
Russia	8800 5009286
Spain	800 000154
Sweden	0200 882255
Switzerland	0800 805353
	Opt. 1 (DE)
	Opt. 2 (FR)
	Opt. 3 (IT)
United Kingdom	0800 0260637

For other unlisted countries:

www.keysight.com/find/contactus
(BP-9-7-17)

DEKRA Certified
ISO 9001 Quality Management System

www.keysight.com/go/quality

Keysight Technologies, Inc.
DEKRA Certified ISO 9001:2015
Quality Management System